

NEW:
The Chubb safes Europa provides the highest level of protection for cash and valuables to international standards



Europa (Grades 3 & 5)

burglary protection

Key Features

- High quality cash safe protecting cash within an office environment with a high level of security of Grade 3 & 5
- The Europa range is tested to ECB.S and conforming to EN1143-1
- Passive and active relockers are incorporated into the boltwork to resist attack
- Chubb safes special barrier material is applied in the construction of the safe to protect against varying kinds of burglary attack
- Each safe can be equipped with high quality fittings to maximise storage requirements
- The Europa can be customised with a choice of locking options, deposits, shelves and lockable drawer deposits in order to meet customer requirements
- Base fixing is standard on all models



Tested to conform to
AS/NZS 3809 (Safes and Strongrooms)
Licenc No: SMK20290

Chubb safes
Trusted the world over.

BURGLARY
RESISTANCE

Product Specifications

- All Chubb safes' locks are tested to VdS and conform to EN1143-1

The Europa 3 & 5 offer Key Lock with Keyless Combination locking as standard. A wide variety of electronic, time delay locks can be fitted on request.



Electronic Lock



Keylock

Internal Fittings

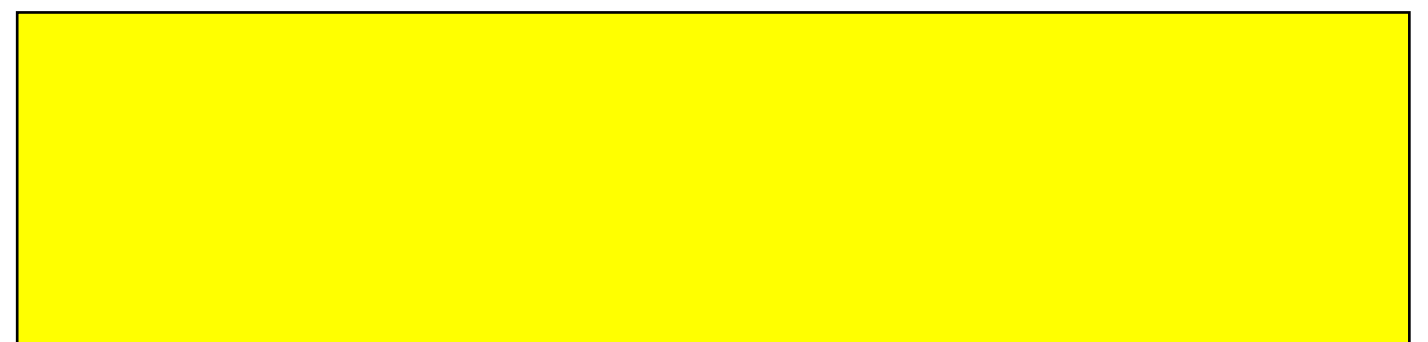
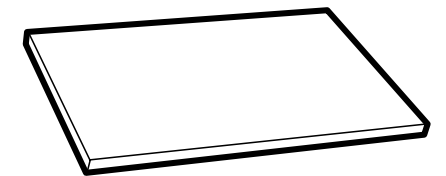
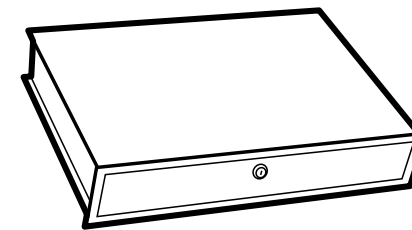
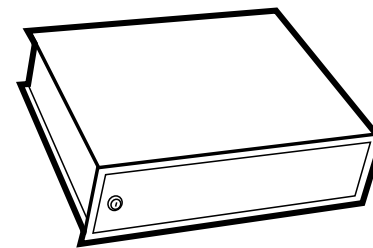

Locking Options

Europa Dimensions

Grade	Size	External			Depth with door at 90° (F)	Width for full access (G)	Internal			Volume (L)	Net Weight (Kg)
		Height (A)	Width (B)	Depth (C)			Height	Width (D)	Depth (E)		
III	2	718	668	663	1277	1232	550	500	420	116	565
	3	1018	668	663	1277	1232	850	500	420	179	750
	4	1208	668	773	1387	1232	1040	500	530	276	1010
	5	1468	668	773	1387	1232	1300	500	530	345	1160
	6	1796	903	663	1510	1680	1628	735	420	503	1635
V	7	1796	903	773	1620	1680	1628	735	530	634	1765
	2	730	680	663	1277	1227	588	538	444	140	645
	3	1030	680	663	1277	1227	888	538	444	212	873
	4	1220	680	773	1387	1227	1078	538	554	322	1107
	5	1480	680	773	1387	1227	1338	538	554	400	1287
	6	1808	915	663	1510	1697	1666	773	444	572	1840
	7	1808	915	773	1620	1697	1666	773	554	715	1968

Installation Guide

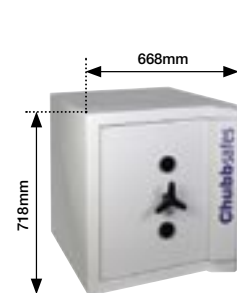
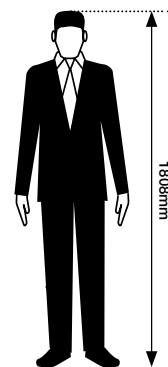
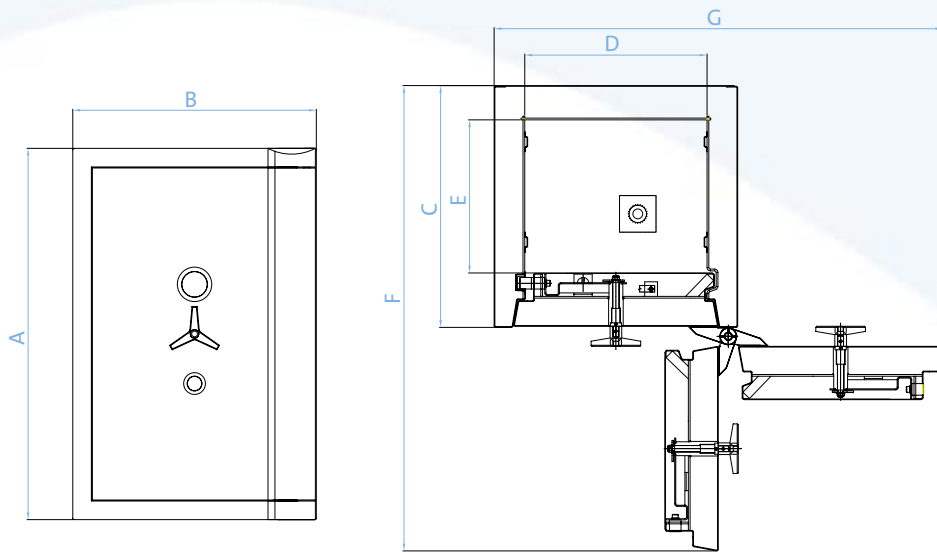

size 2

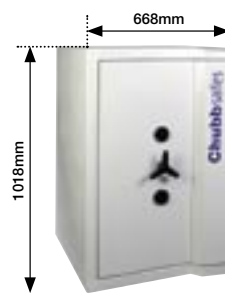

size 3

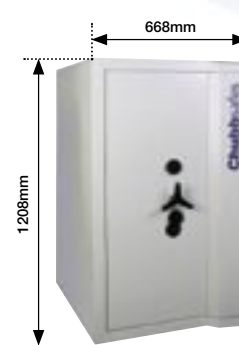

size 4

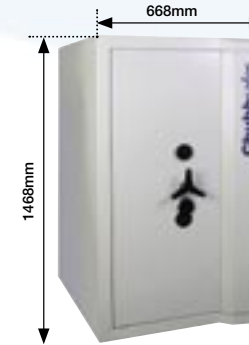

size 5



size 6

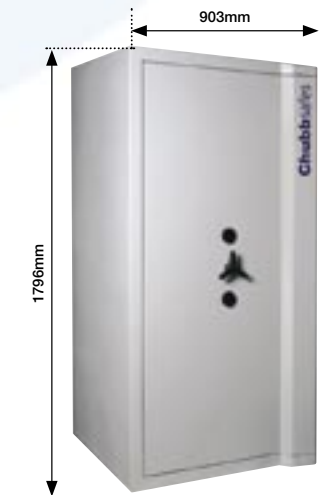

size 7

NB: Fire protection is only available on sizes in Grade I-II

Testing

A range of attack tools are used in the testing of Chubb safes Europa products from basic tools to the sophisticated tools like oxy-acetylene.



The Europa has been tested to the highest quality in its class against attack.



Customising

Please ask for further assistance on how we can customise your storage requirements for secure, convenient use.

- Inner compartment as specified by customers



- Prepared to accept pneumatic system for depositing



- Envelope slot with anti-fish device



- Drawer deposit front or rear

